

201.CS2323-8

Cord set with plug Type 2 32A 1P
cable 3x6+1x0,5 7,5m - connector Type 2 32A 1P

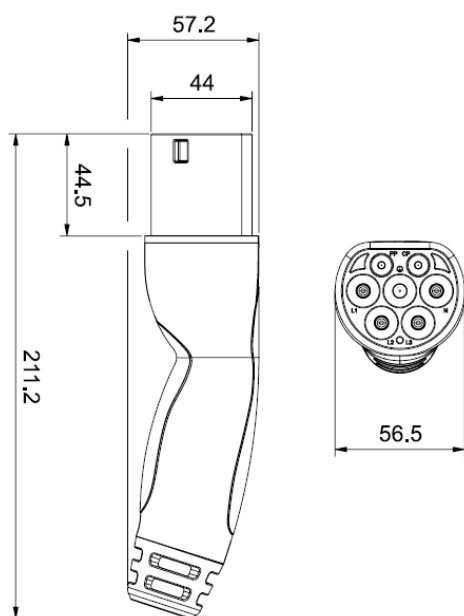

> PLUG DIMENSIONS



> CONNECTOR DIMENSIONS

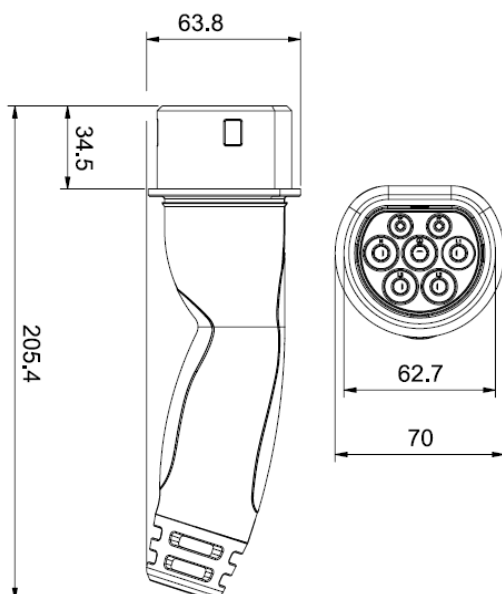

> REFERENCE STANDARD

EN 62196-1

Plugs, socket-outlets, vehicle couplers and vehicle inlets.
Conductive charging of electric vehicles.
Part 1: General requirements.

EN 62196-2

Plugs, socket-outlets and vehicle couplers.
Conductive charging of electric vehicles.
Part 2: Dimensional interchangeability requirements
for a.c. pin and contact-tube accessories.

EN 50620

Electric cables - Charging cables for electric vehicles

> TECHNICAL CHARACTERISTICS

Rated current:	32A
Rated voltage:	200-250VAC
Frequency:	50-60Hz
Insulating voltage:	500V
Protection degree:	IP44
Operating temperature:	-30°C +50°C
Material:	Engineering plastic
Salt mist:	Resistant
UV radiation:	Resistant

> CABLE

Rated voltage:	450/750V
Insulation/Sheath:	PUR
Max. temperature:	+90°C