

201.CS2424-8

Cord set con spina Tipo 2 32A 3P
cavo 5x6+1x0,5 7,5m - presa Tipo 2 32A 3P

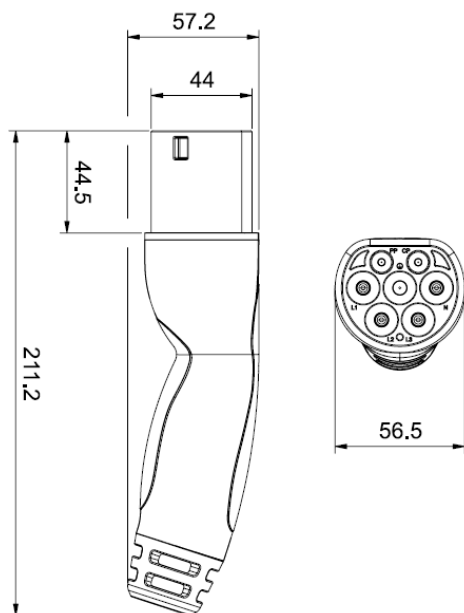

> DIMENSIONI SPINA



> DIMENSIONI PRESA

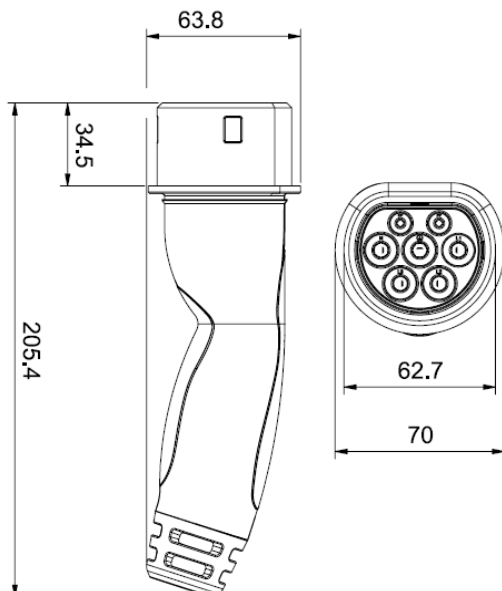

> NORME DI RIFERIMENTO

EN 62196-1

Plugs, socket-outlets, vehicle couplers and vehicle inlets.
Conductive charging of electric vehicles.
Part 1: General requirements.

EN 62196-2

Plugs, socket-outlets and vehicle couplers.
Conductive charging of electric vehicles.
Part 2: Dimensional interchangeability requirements
for a.c. pin and contact-tube accessories.

EN 50620

Electric cables - Charging cables for electric vehicles

> CARATTERISTICHE TECNICHE

Corrente nominale:	32A
Tensione nominale:	380-480VAC
Frequenza:	50-60Hz
Tensione d'isolamento:	500V
Grado di protezione:	IP44
Temperatura d'impiego:	-30°C +50°C
Materiale:	Tecnopolimero
Soluzione salina:	Resistente
Raggi UV:	Resistente

> CAVO

Tensione nominale:	450/750V
Isolante/Guaina:	PUR
Temperatura massima:	+90°C