

DIAMETRO MASSIMO FORATURA PANNELLO  
MAX PANEL DRILLING HOLE

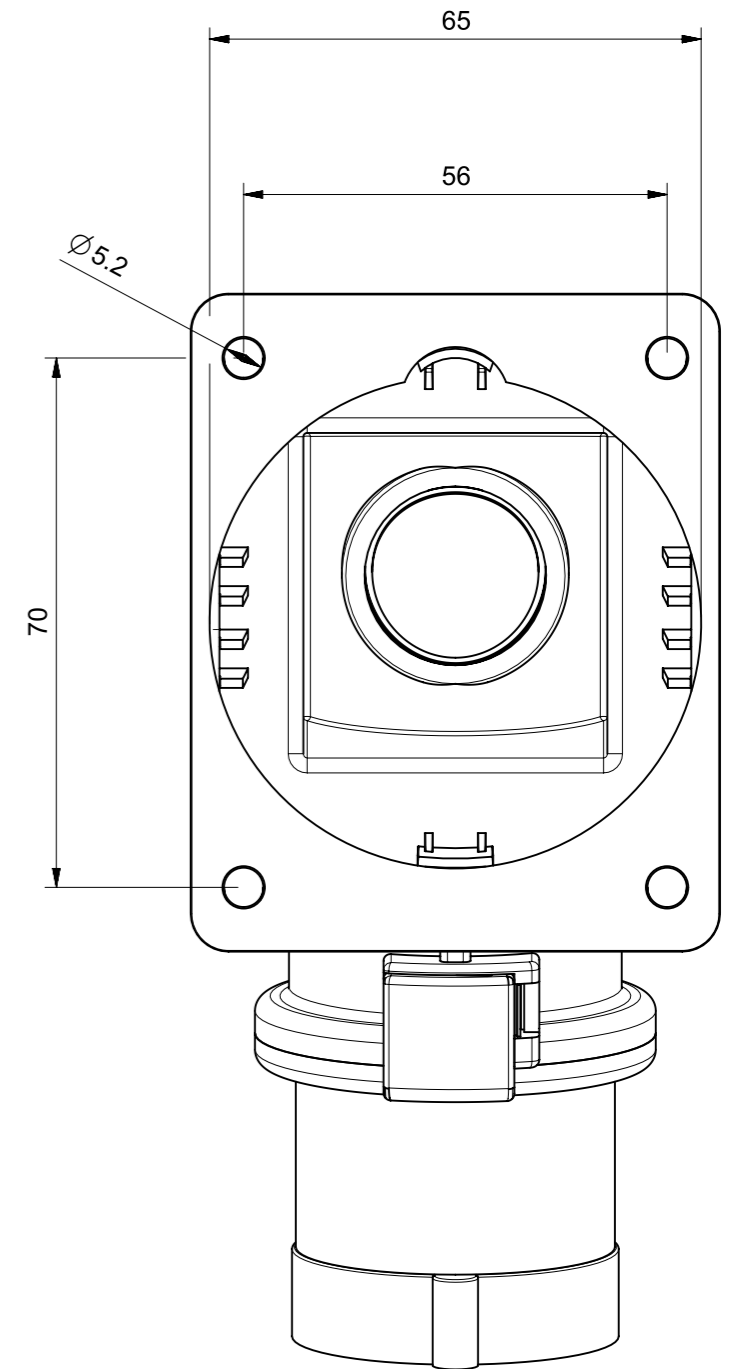

IL DISEGNO SI RIFERISCE ALLA POSIZIONE ORARIA 6h  
DWG REFERS TO CLOCK POSITION 6h

At the end of the law, we reserve the ownership of this design may not be copied and transfer it to third parties or competitors	Format	A3	Scale	1:1	Mould N°	1000XXXX	Drawn	SCAME
	Tolerances for linear and angular dimensions without indication of specific tolerances: JS13 / UNI 286-1:2010							Date
 S.p.A. PARRE - (Bergamo)	DESCRIPTION						Approved	
	SPINA FISSA DA PARETE 2P+T 16A IP44						CODICE	Sheet 1 / 1