

Ø 53

DIAMETRO FORATURA PANNELLO
PANEL DRILLING HOLE

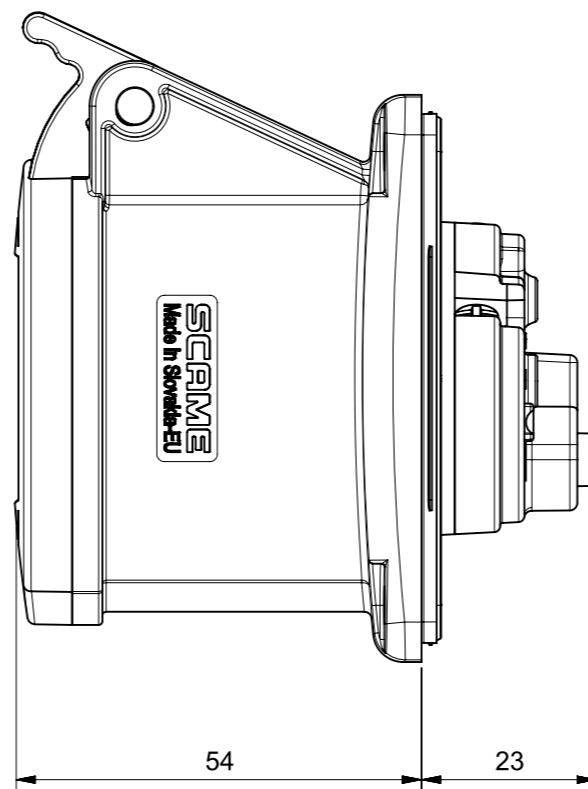

54

23

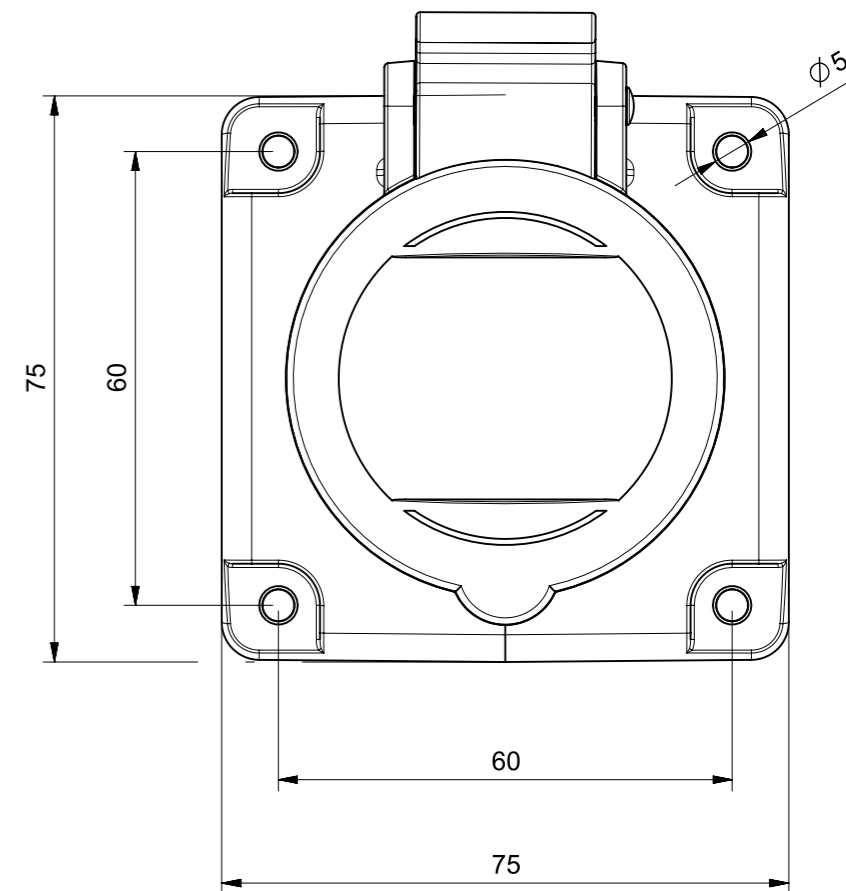

75

60

60

75

Ø5

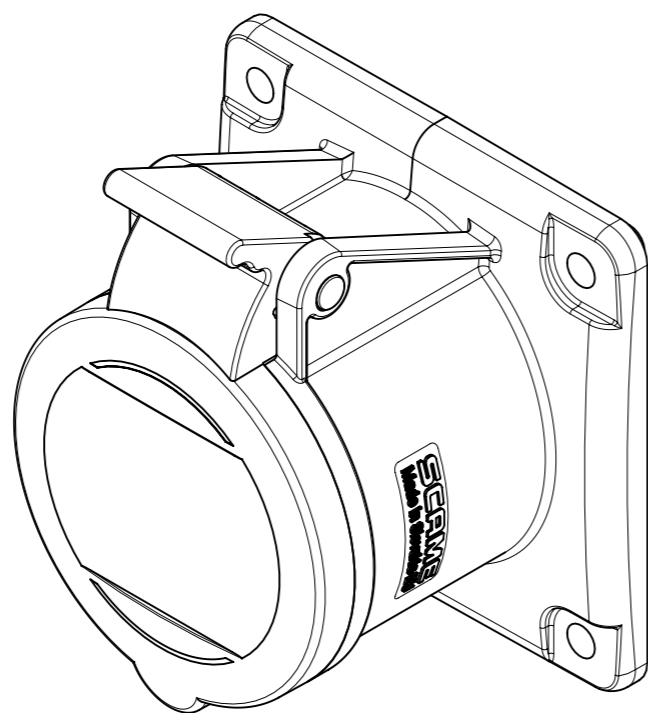

IL DISEGNO SI RIFERISCE ALLA POSIZIONE 6h
DWG REFERS TO CLOCK POSITION 6h

At the end of the law, we reserve the ownership of this design may not be copied and transfer it to third parties or competitors	Format	A3	Scale	1:1	Mould N°	Drawn	SCAME
	Tolerances for linear and angular dimensions without indication of specific tolerances: JS13 / UNI 286-1:2010						Date
 S.p.A. PARRE - (Bergamo)	DESCRIPTION					Approved	
	PRESA INC.DIR. 3P+T 16A IP44 FLANGIA 75x75					CODICE	Sheet 1 / 1