

Sezione A-A

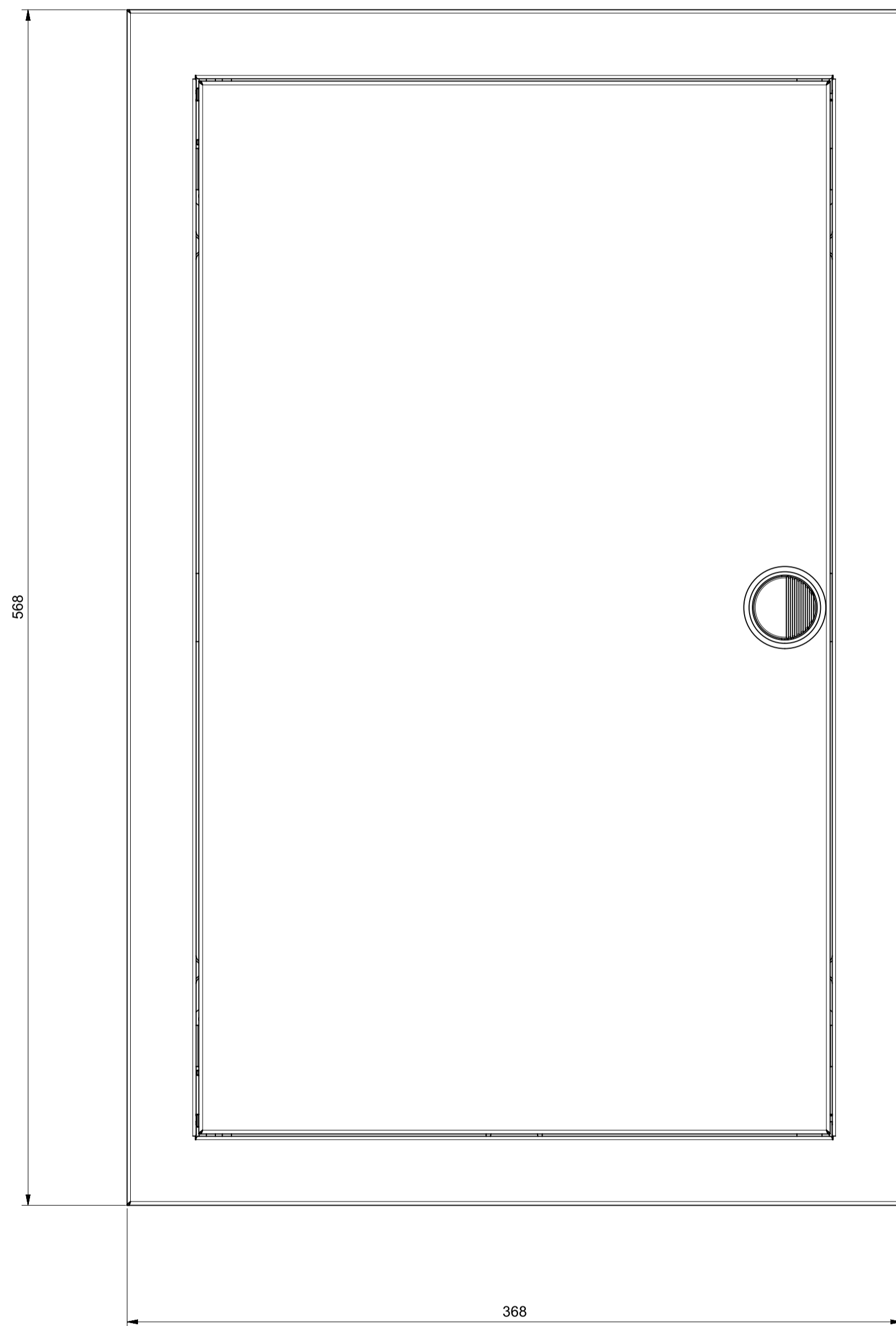
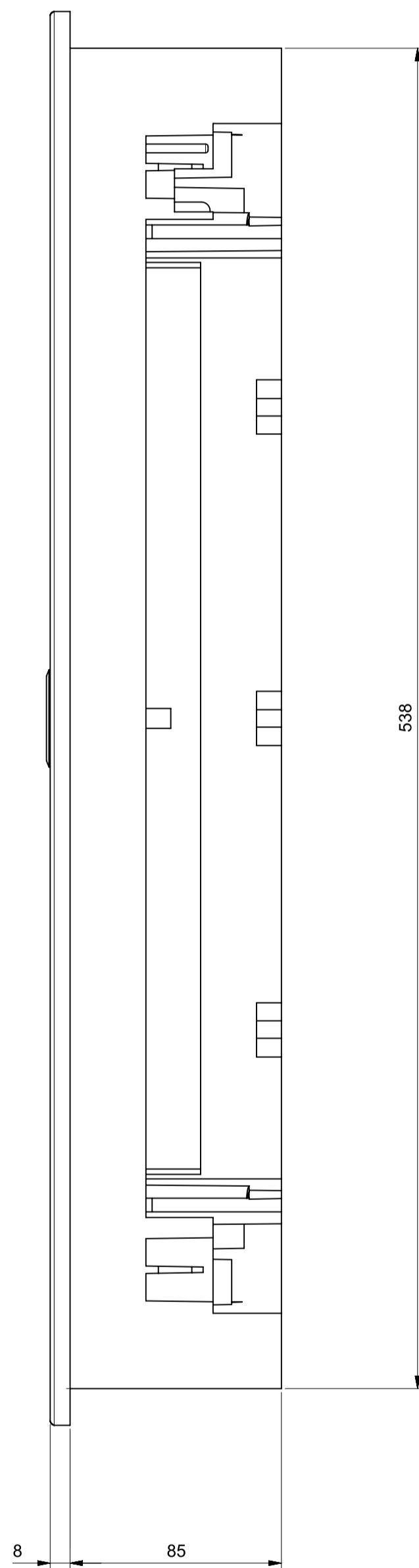
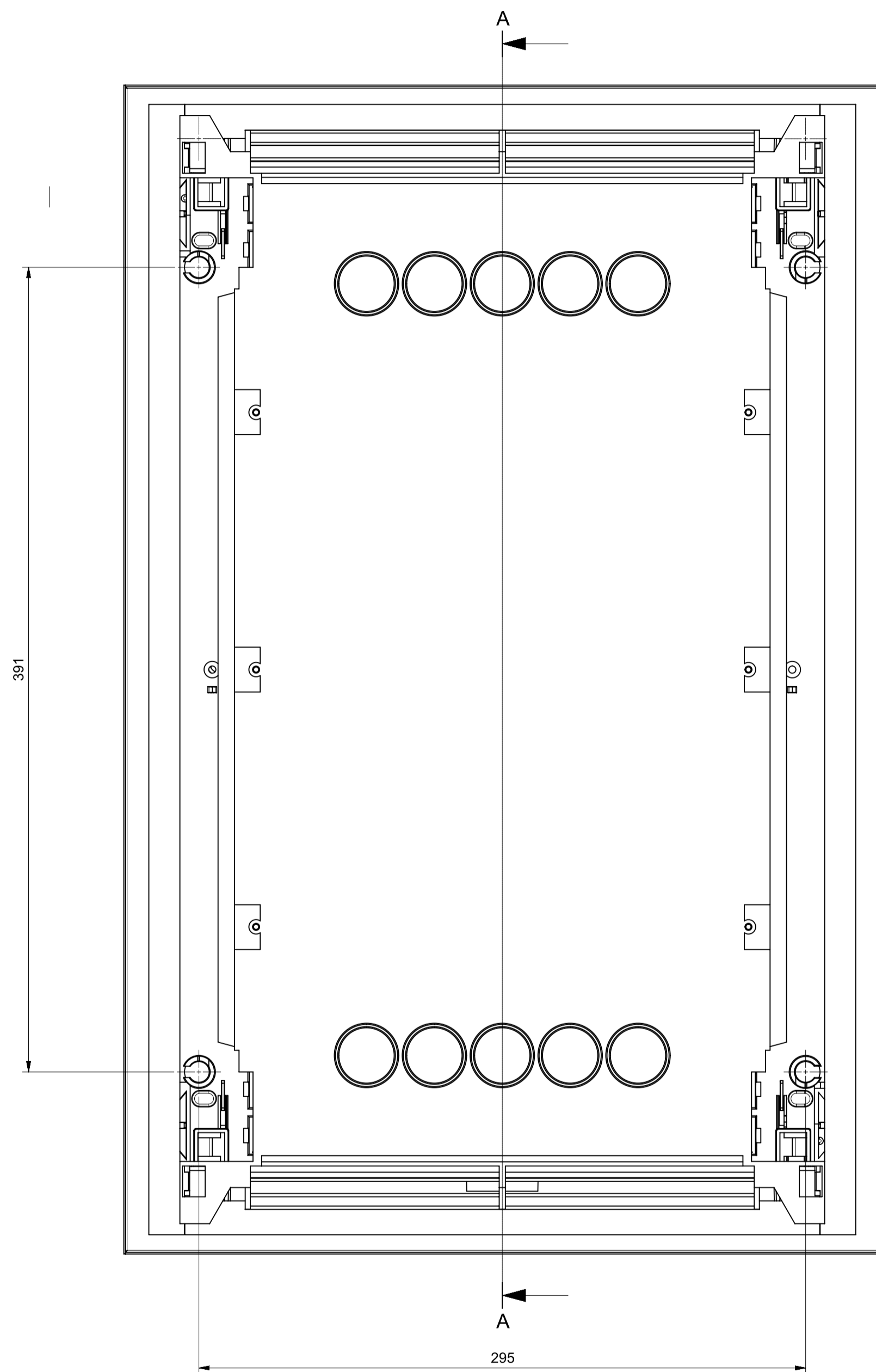
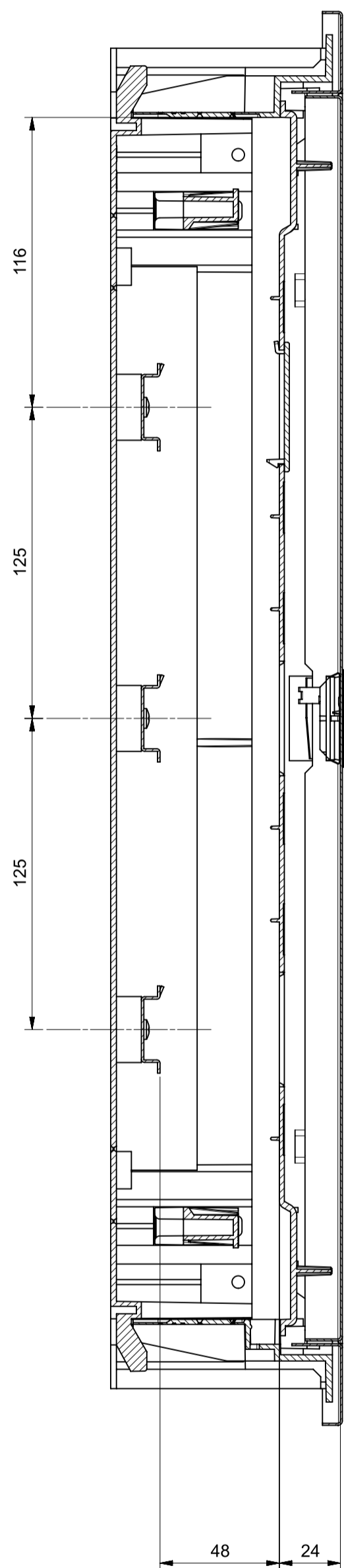

Under the terms of the law we reserve the ownership of this design may not be copied and transfer it to third parties or competitors SCAME S.p.A. PARRE - (Bergamo)	Format	A1	Scale	1:2	Mould N°	1000XXXX	Drawn	SCAME
	Tolerances for linear and angular dimensions without indication of specific tolerances: JS13 / UNI 286-1:2010							Date
DESCRIPTION CENTRALINO FILO MURO 3 FILE 36 MODULI							Approved	Sheet 1 / 1
							CODE	4009520